



Built in conformance with NSF 50 and SPS 3 standards



## FEATURES

- Adjustable collar
- New weir clip lock secures the clips in the weir door
- Weir plate with easy snap in and out locks
- Large self-contained basket with lock-in feature (will not float)
- Pre-installed O-ring for float assembly
- Underwater dampers on face plate for noise reduction on weir plate – especially on windy days
- Super strong engineered polymer upper housing
- Extra heavy duty PVC lower unit (no transitional glue required)
- 2½" outside slip and 2" inside slip (outside skimmer)
- 2" threads for pressure testing (inside skimmer)
- Built-in overflow or fill line knock out
- Upper housing has pre-cut rebar cut outs with pre-drilled holes for tie wire
- Skimmer Lid and Collar G154 UV tested
- NSF 50 approved for commercial use, 25 GPM min, 55 GPM max – approved for residential use up to 100 GPM
- Optional custom name/logo engraved on lid (requires minimum 100 piece lid order)
- 1 per case

Now available with three lid options:  
round, square or snap-in round/square



Optional vacuum plate with snap-in lug can be glued in under lid for easy storage p/n SK43xx

Part # SKR2xxx

## STANDARD COLORS

- SKR201 – White
- SKR202 – Black
- SKR203 – Light Gray
- SKR204 – Blue
- SKR205 – Dark Gray
- SKR208 – Tan

Snap-in Round/Square Lid and Collar (sold separately) p/n SK65xxx

Square Lid and Collar (sold separately) p/n SK64xxx

Available without lid and collar SKR2NL101 (white only)

**SPS 3 & NSF 50 Compliant**

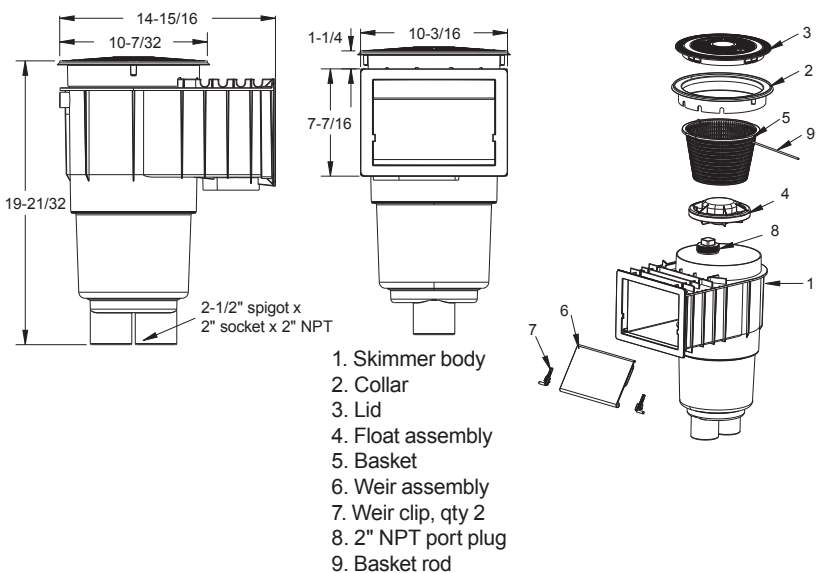

# SKIMMER OPTIONS

STANDARD COLORS



101 102 103 104 105 108

## Standard Waterstop Face Round Lid

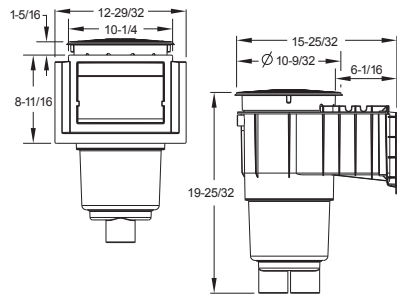

**SKR1xx**  
Standard Skimmer  
with Waterstop Face  
Dual Bottom Port  
2½" Spigot x 2" Socket

**SKR1xxD**  
Single Bottom Port  
4" Socket

**SKR1xxF**  
Single Bottom Port  
6" Socket

page 92

## Standard Flush Face Round Lid

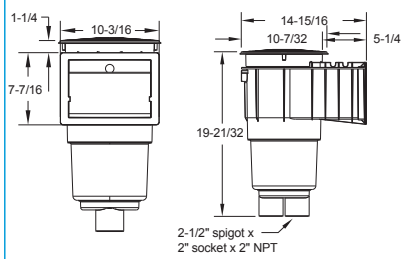

**SKR2xx**  
Standard Skimmer  
with Flush Face  
Dual Bottom Port  
2½" Spigot x 2" Socket

**SKR2xxD**  
Single Bottom Port  
4" Socket

**SKR2xxF**  
Single Bottom Port  
6" Socket

page 93

## Standard Waterstop Face Square Lid

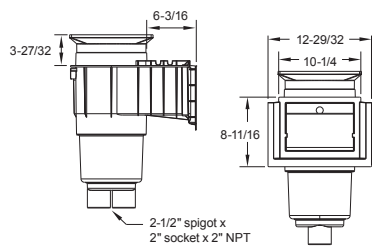

**SK64xxx** Square Lid and  
Collar (sold separately)

**SKR1xx**  
Standard Skimmer  
with Waterstop Face  
Dual Bottom Port  
2½" Spigot x 2" Socket

**SKR1xxD**  
Single Bottom Port  
4" Socket

**SKR1xxF**  
Single Bottom Port  
6" Socket

page 92

## Standard Flush Face Square Lid

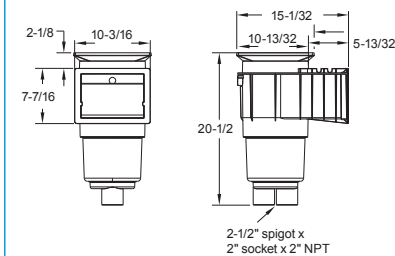

**SK64xxx** Square Lid and  
Collar (sold separately)

**SKR2xx**  
Standard Skimmer  
with Flush Face  
Dual Bottom Port  
2½" Spigot x 2" Socket

**SKR2xxD**  
Single Bottom Port  
4" Socket

**SKR2xxF**  
Single Bottom Port  
6" Socket

page 93

## Standard Waterstop Face Round/Square Snap-in Lid

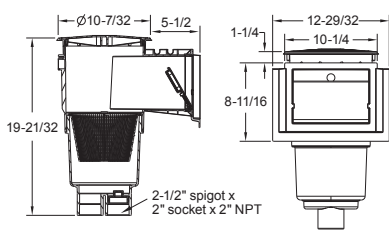

**SK65xxx** Snap-in  
Round/Square Lid and  
Collar (sold separately)

**SKR1xxx**  
with Float Assembly  
Dual Bottom Port  
2½" Spigot x 2" Socket

**SKR1xxxD**  
Single Bottom Port  
4" Socket

**SKR1xxxF**  
Single Bottom Port  
6" Socket

page 92

## Standard Flush Face Round/Square Snap-in Lid

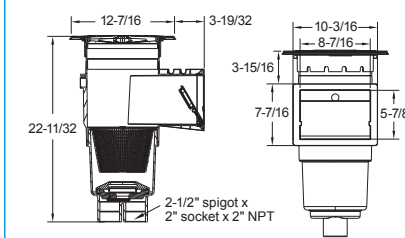

**SK65xxx** Snap-in  
Round/Square Lid and  
Collar (sold separately)

**SKR2xxx**  
with Float Assembly  
Dual Bottom Port  
2½" Spigot x 2" Socket

**SKR2xxxD**  
Single Bottom Port  
4" Socket

**SKR2xxxF**  
Single Bottom Port  
6" Socket

page 93

## Standard Waterstop Face Round/Square Snap-in Lid

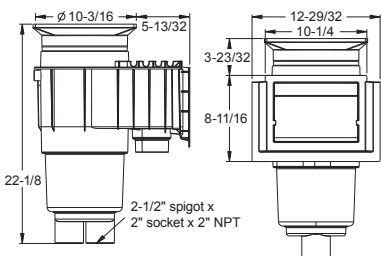

**SK65xxx** Snap-in  
Round/Square Lid and  
Collar (sold separately)

**SKR1xx-OZ**  
with Float Assembly  
and new Ozone Port  
Dual Bottom Port  
2½" Spigot x 2" Socket

page 94

## Standard Flush Face Round/Square Snap-in Lid

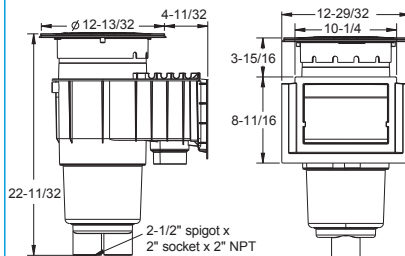

**SK65xxx** Snap-in  
Round/Square Lid and  
Collar (sold separately)

**SKR2xx-OZ**  
with Float Assembly  
and new Ozone Port  
Dual Bottom Port  
2½" Spigot x 2" Socket

page 95